

ALKOR

ALUMINUM



ENDÜSTRİYEL PROFİLLER

INDUSTRIAL PROFILES

- **HALI VE SÜPÜRGELİK PROFİLLERİ** / CARPET AND BASEBOARD PROFILES
- **MOBİLYA PROFİLLERİ** / FURNITURE PROFILES
- **SERA PROFİLLERİ** / GREENHOUSE PROFILES
- **SANAYİ VE KAROSER PROFİLLERİ** / INDUSTRIAL AND BODYWORK PROFILES
- **ELEKTRONİK PROFİLLERİ** / ELECTRONIC PROFILES
- **DİLATASYON PROFİLLERİ** / DILATATION PROFILES
- **OTOMOTİV PROFİLLERİ** / AUTOMOTIVE PROFILES
- **REKLAM PROFİLLERİ** / ADVERTISING PROFILES
- **KLİMA & MENFEZ PROFİLLERİ** / AIR CONDITION & VENT PROFILES
- **ÖZEL AMAÇLI PROFİLLERİ** / SPECIAL PURPOSE PROFILES
- **SERAMİK CEPHE SİSTEM PROFİLLERİ** / CERAMIC FACADE SYSTEM PROFILES
- **SİNERFLEX PROFİLLERİ** / SİNERFLEX PROFILES

HALI VE SÜPÜRGELİK PROFİLLERİ

CARPET AND BASEBOARD PROFILES

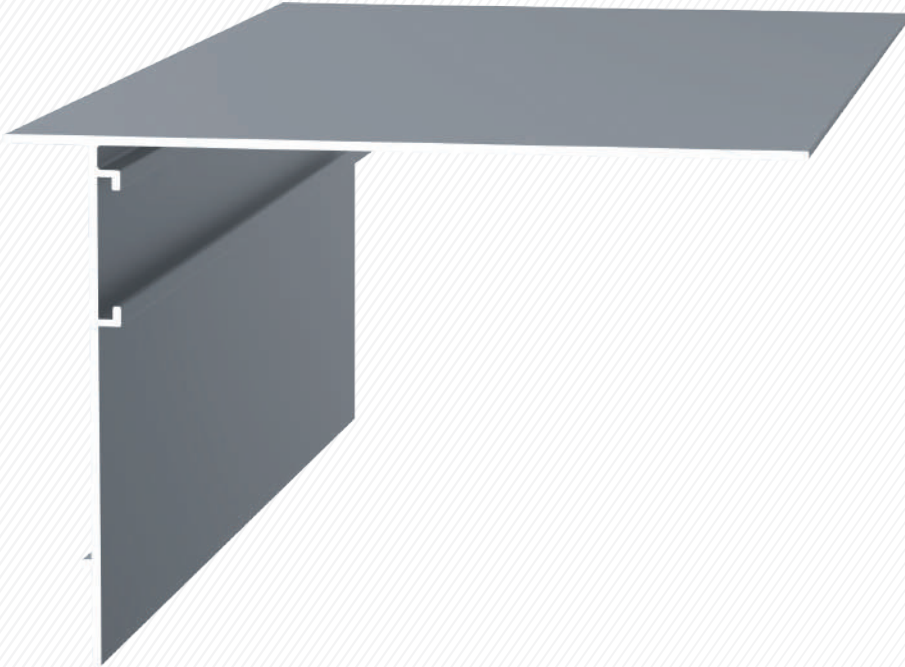

Profiller / Profiles

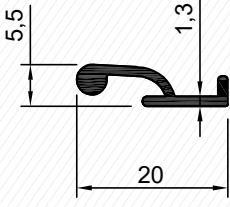

287
0,117 kg/m

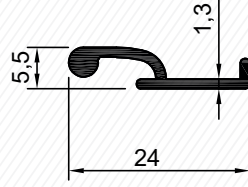

288
0,133 kg/m

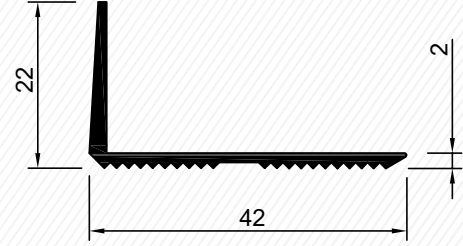

350
0,262 kg/m

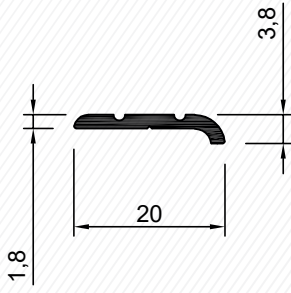

351
0,093 kg/m

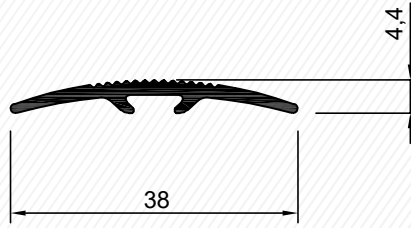

352
0,190 kg/m

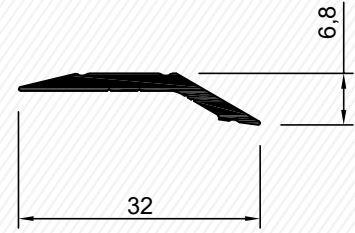

353
0,167 kg/m

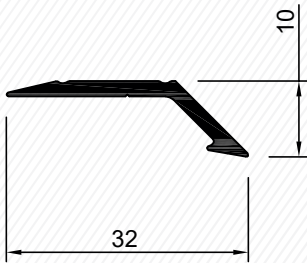

354
0,173 kg/m

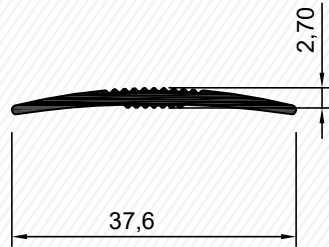

355
0,181 kg/m

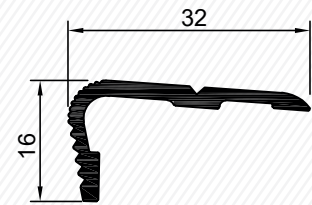

421
0,237 kg/m

Profiller / Profiles

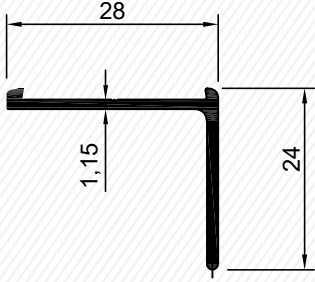

425
0,195 kg/m

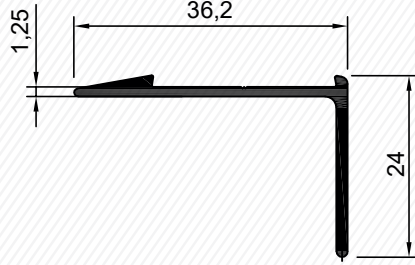

426
0,233 kg/m

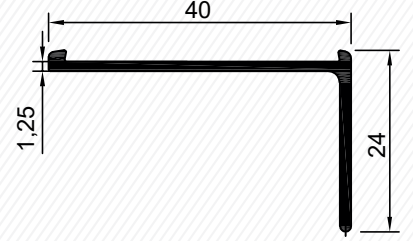

427
0,236 kg/m

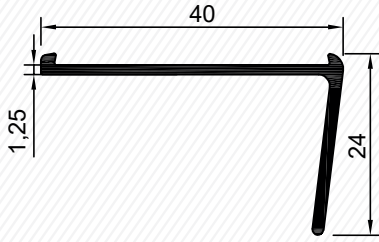

428
0,236 kg/m

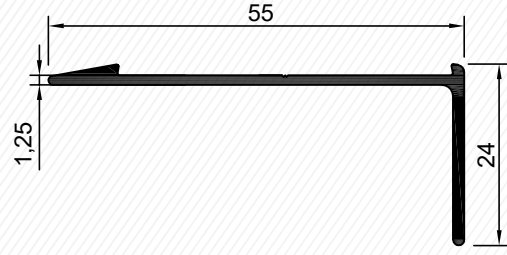

429
0,295 kg/m

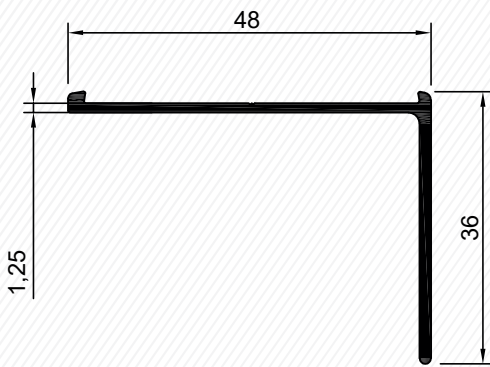

430
0,312 kg/m

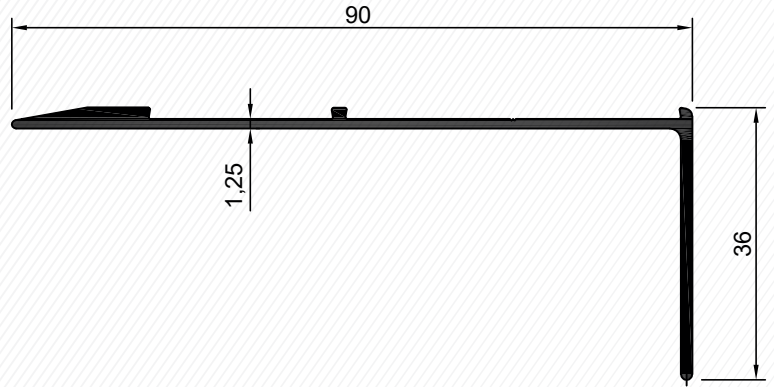

431
0,505 kg/m

Profiller / Profiles

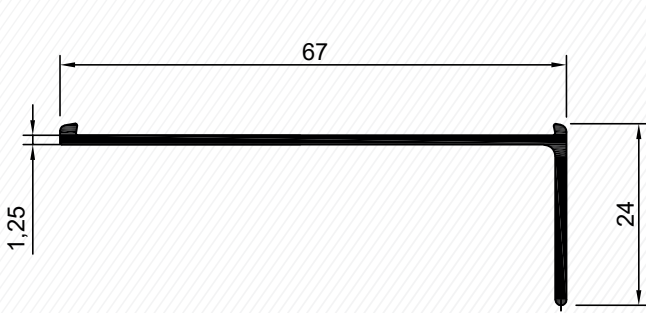

432
0,327 kg/m



433
0,376 kg/m

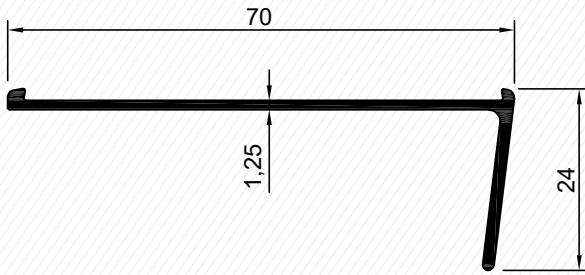

434
0,328 kg/m

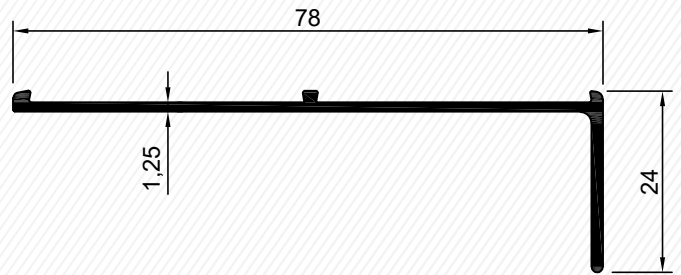

435
0,372 kg/m

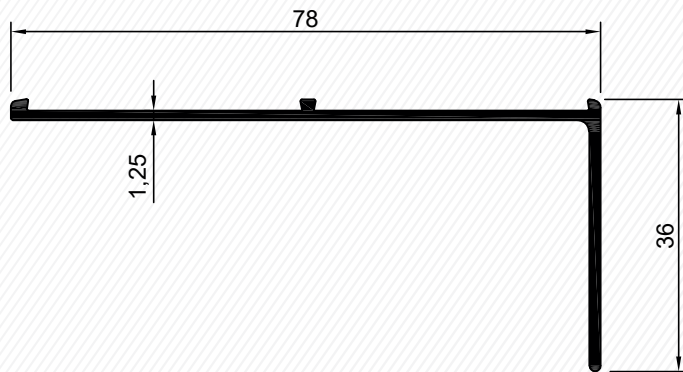

436
0,420 kg/m

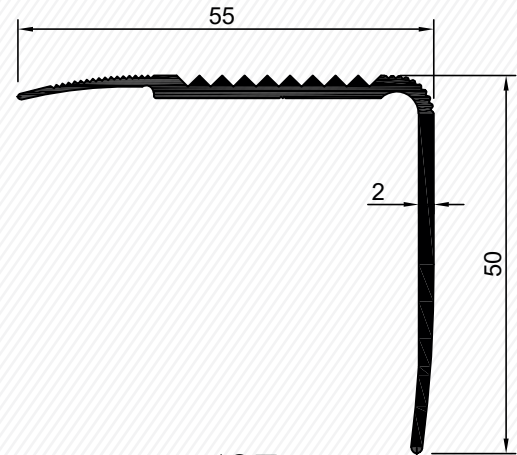

437
0,506 kg/m

Profiller / Profiles

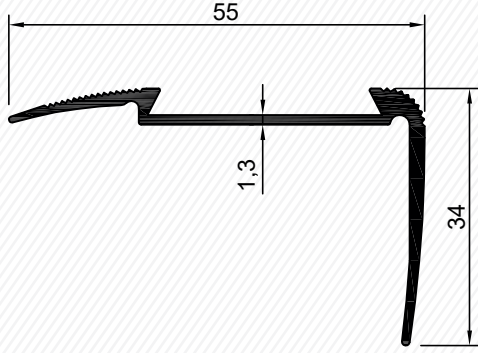

439
0,368 kg/m

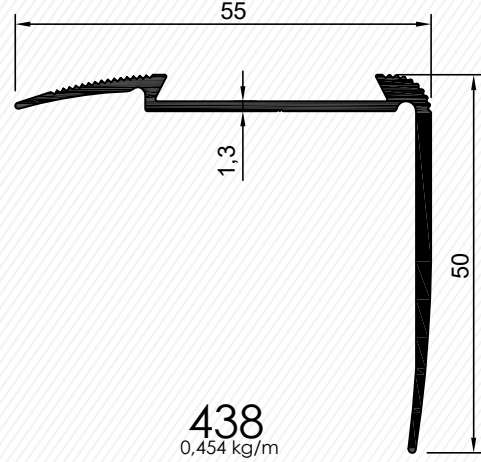

438
0,454 kg/m

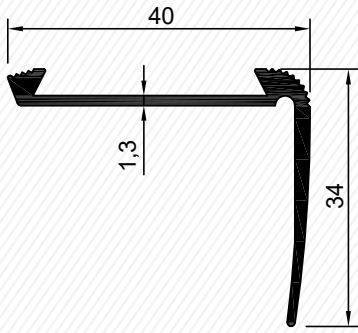

440
0,325 kg/m

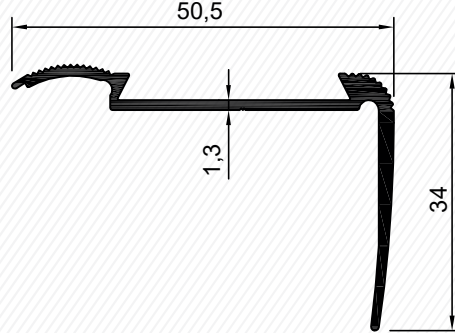

441
0,349 kg/m

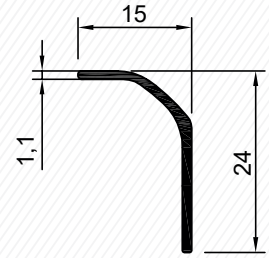

504
0,108 kg/m

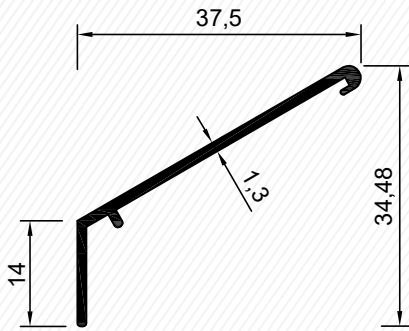

505
0,208 kg/m

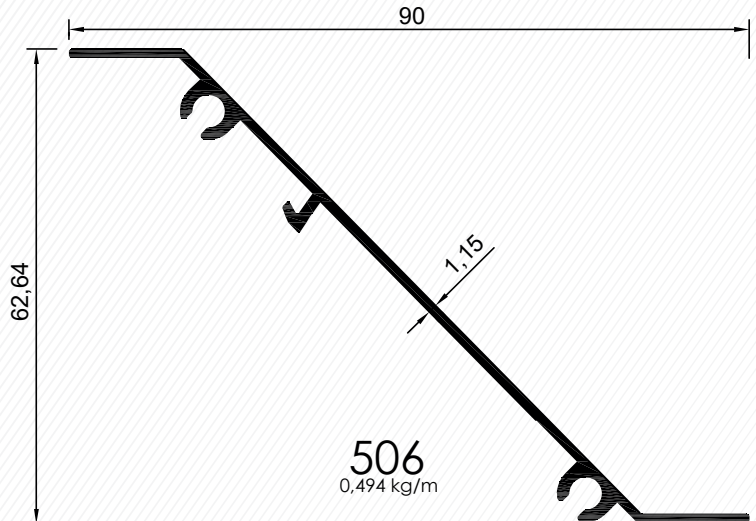

506
0,494 kg/m

Profiller / Profiles

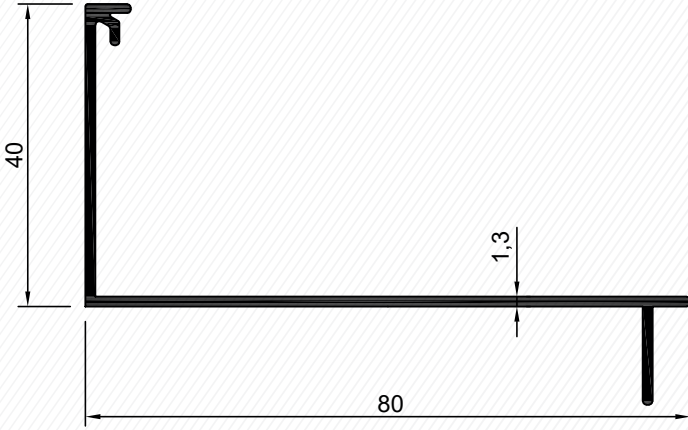

507
0,497 kg/m

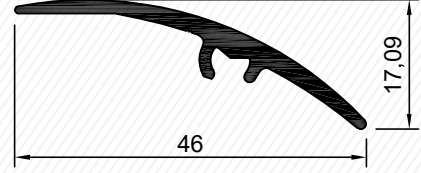

572 A
0,319 kg/m

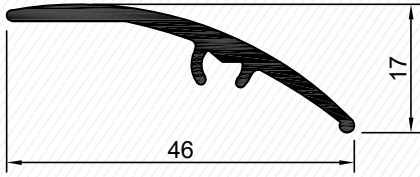

572
0,322 kg/m

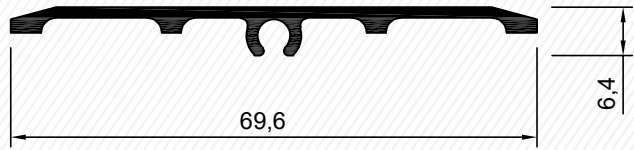

573
0,374 kg/m

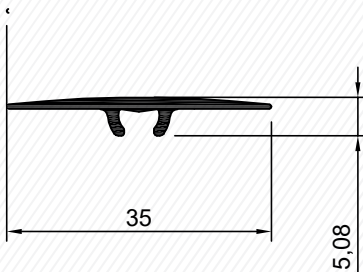

574
0,144 kg/m

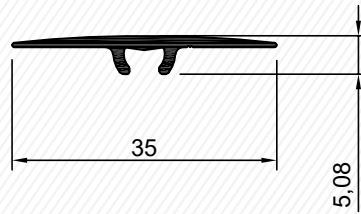

574-A
0,157 kg/m

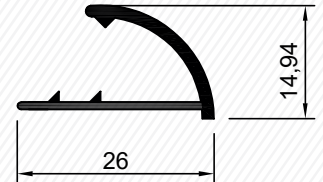

575
0,175 kg/m

Profiller / Profiles

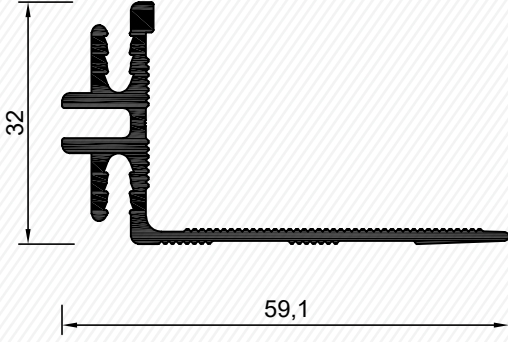
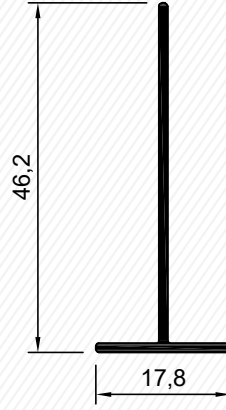
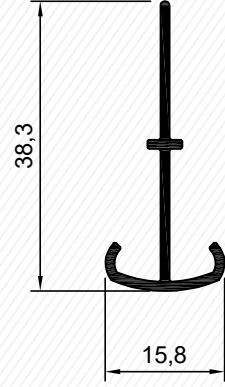
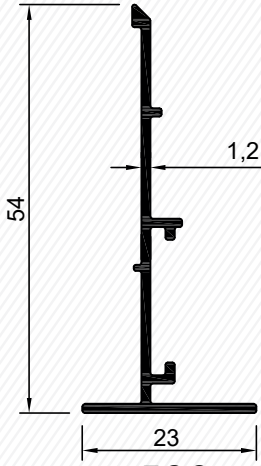
577-A
0,593 kg/m578
0,203 kg/m579
0,206 kg/m

580

0,290 kg/m

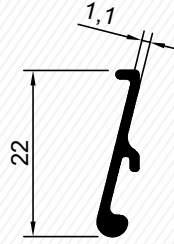

581

0,102 kg/m

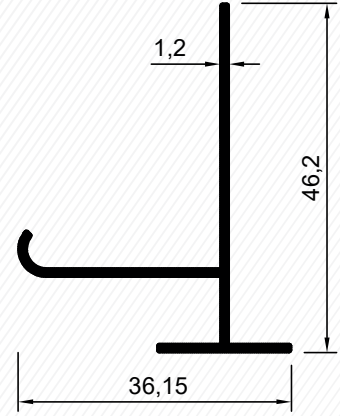

595

0,302 kg/m

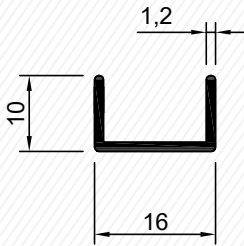

596

0,108 kg/m

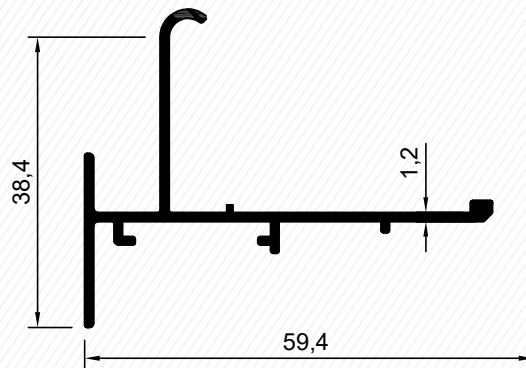

598

0,394 kg/m

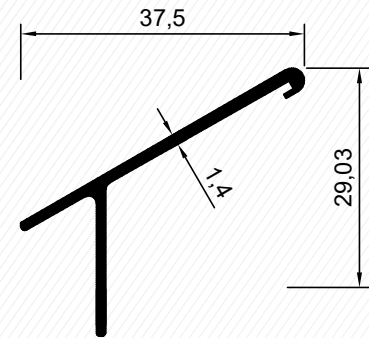

599

0,230 kg/m

Profiller / Profiles

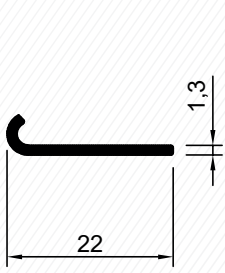

625
0,088 kg/m

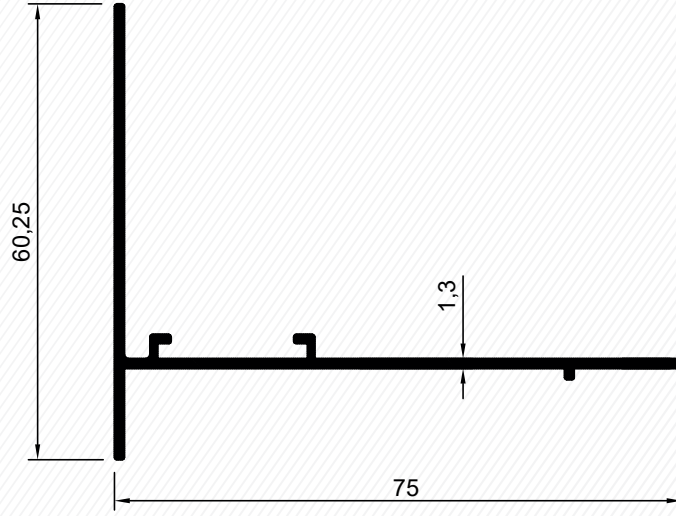

626
0,508 kg/m

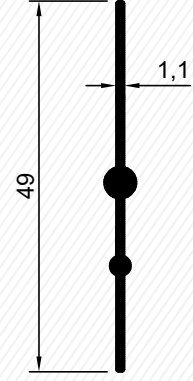

627
0,181 kg/m

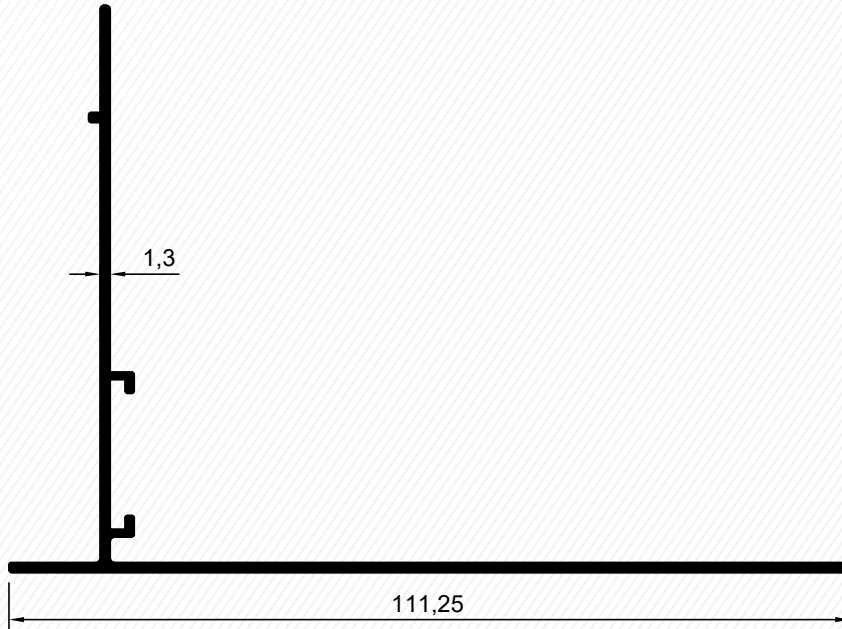

628
0,685 kg/m

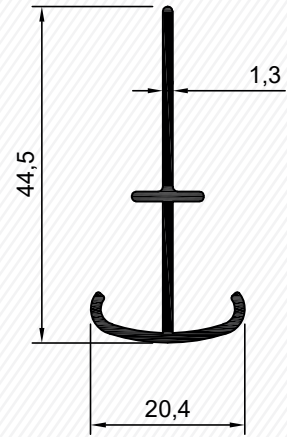

629
0,275 kg/m

Profiller / Profiles

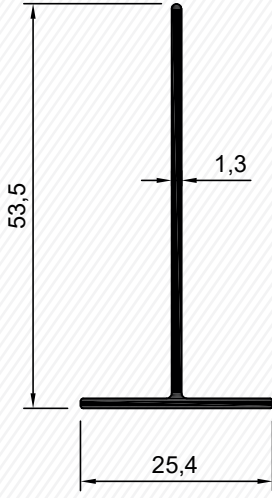
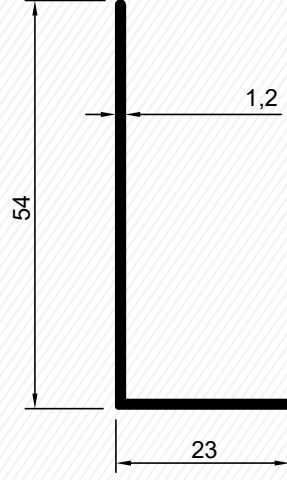
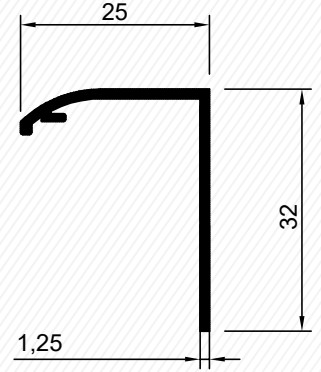
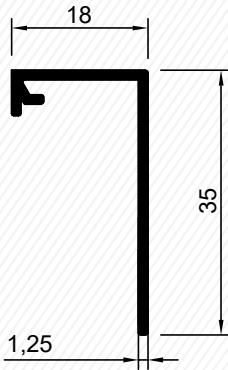
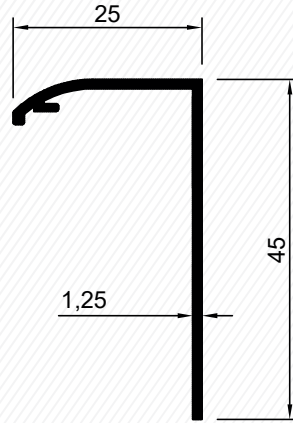
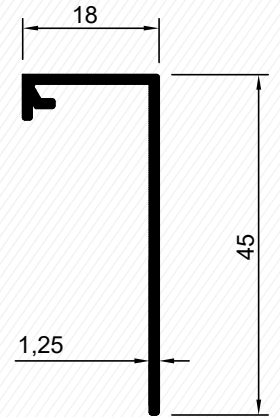
**630**
0,273 kg/m**631**
0,246 kg/m**689**
0,204 kg/m**690**
0,203 kg/m**691**
0,247 kg/m**692**
0,237 kg/m

Profiller / Profiles

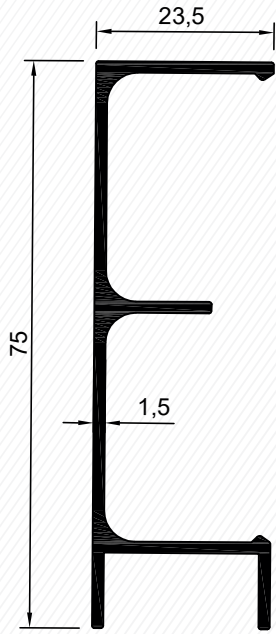

701
0,663 kg/m

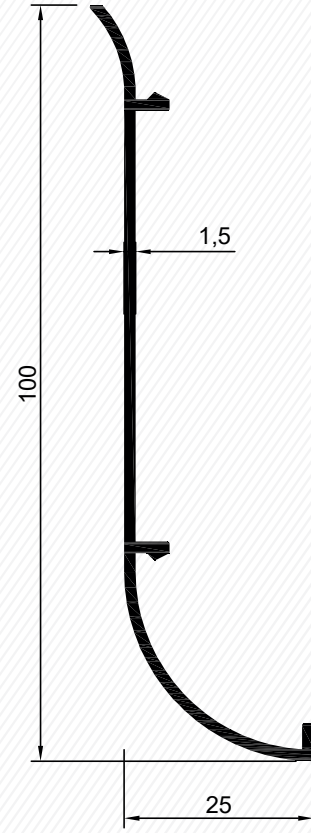

702
0,523 kg/m

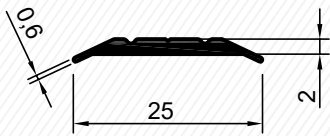

830
0,103 kg/m

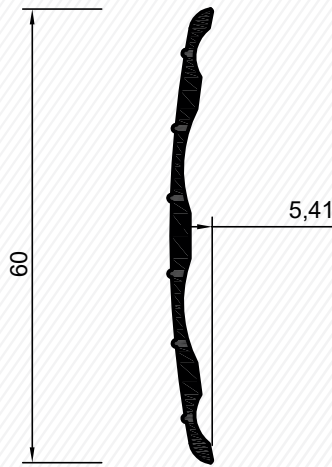

831
0,297 kg/m

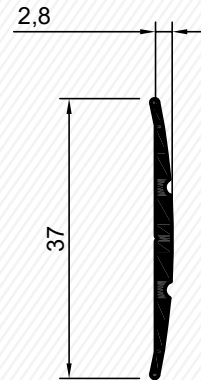

832
0,158 kg/m

Profiller / Profiles

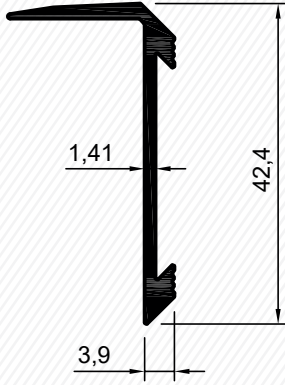
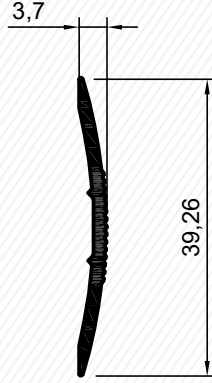
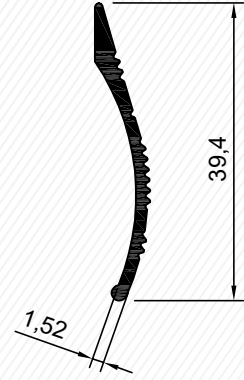
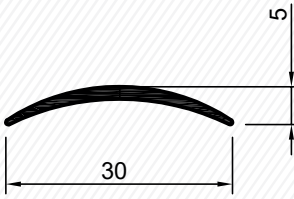
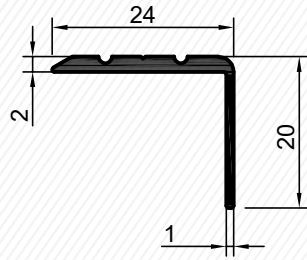
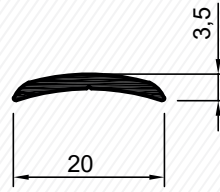
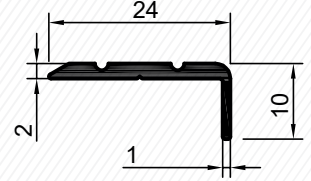
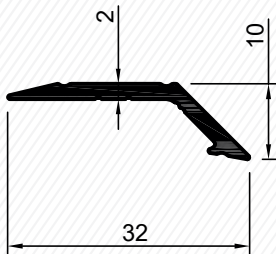
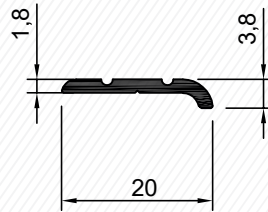
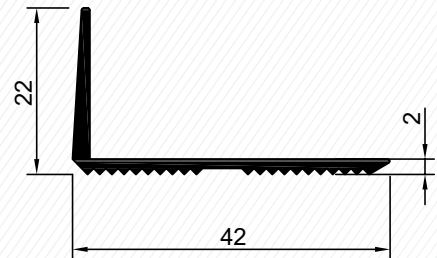
833
0,286 kg/m834
0,158 kg/m835
0,185 kg/m836
0,106 kg/m837
0,163 kg/m838
0,096 kg/m839
0,136 kg/m840
0,171 kg/m841
0,093 kg/m842
0,262 kg/m

Profiller / Profiles

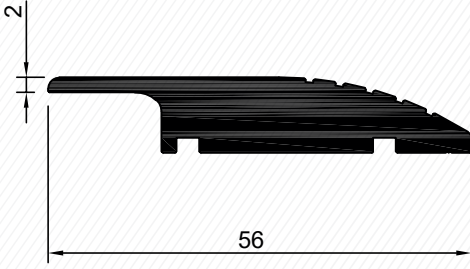

938
0,988 kg/m

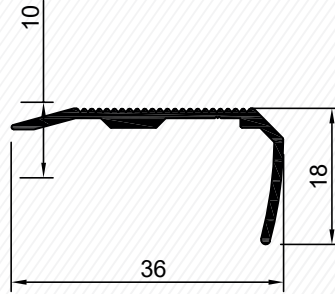

939
0,191 kg/m

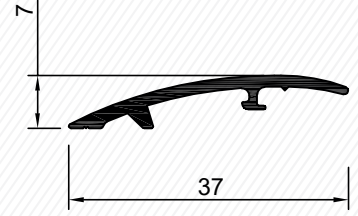

942
0,181 kg/m

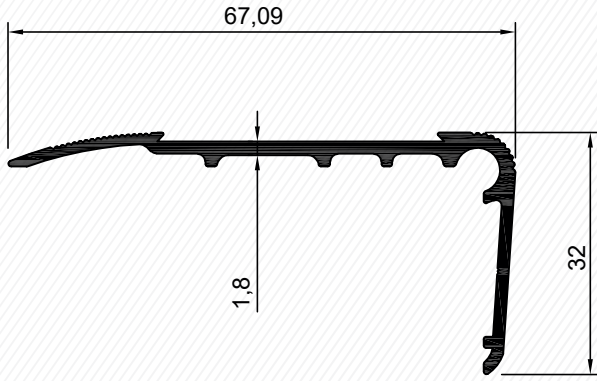

957
0,477 kg/m

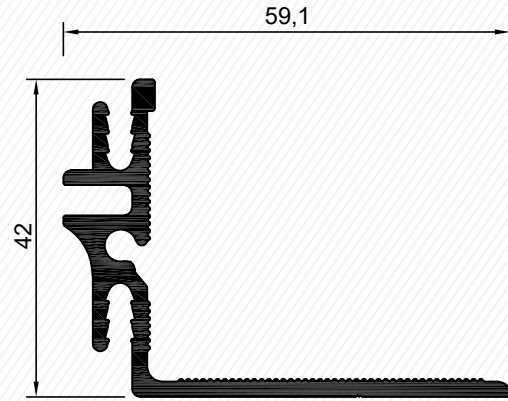

958
0,780 kg/m

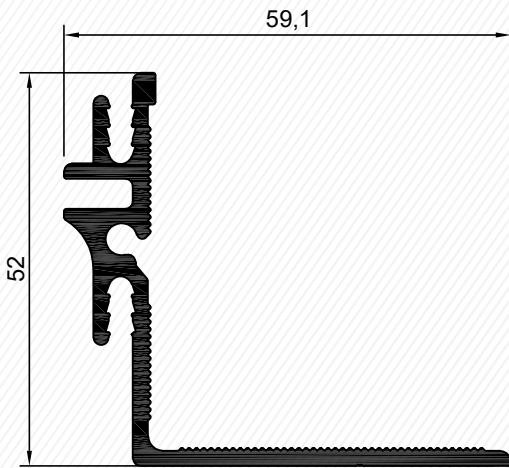

959
0,844 kg/m

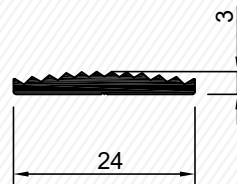

968
0,146 kg/m

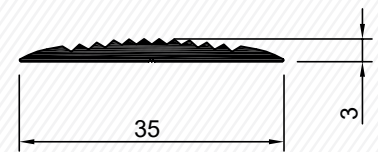

969
0,185 kg/m

Profiller / Profiles

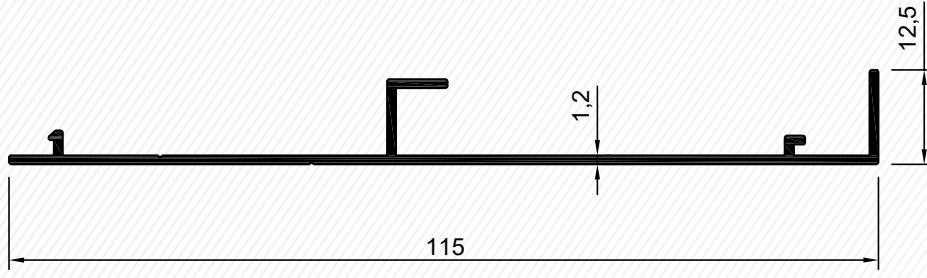

987
0,490kg/m

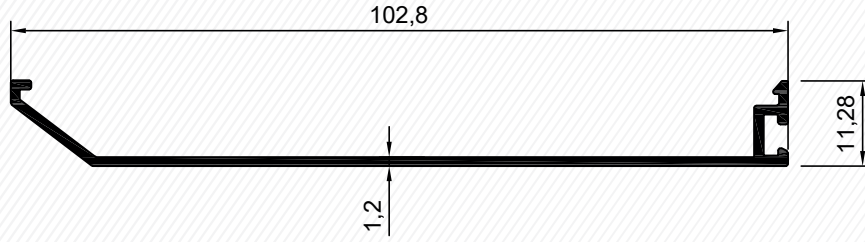

988
0,411kg/m

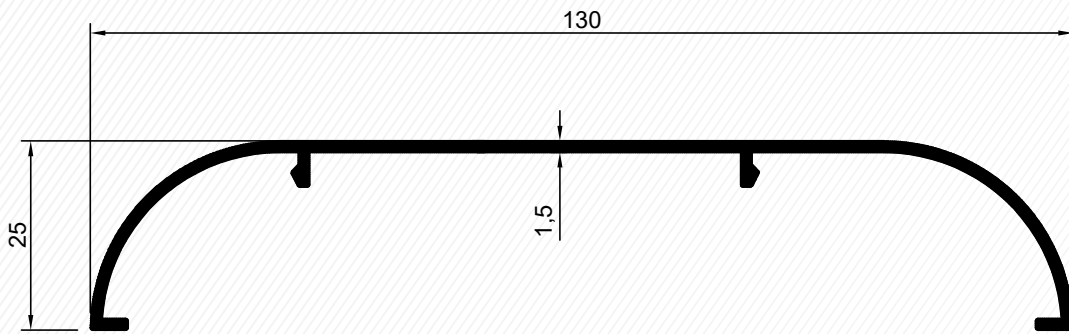

1297
0,708 kg/m

Profiller / Profiles

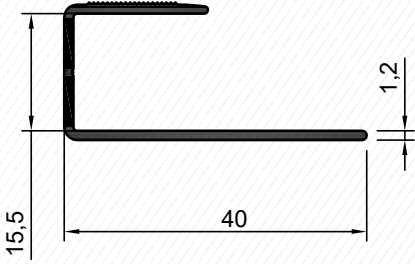

1437
0,242 kg/m

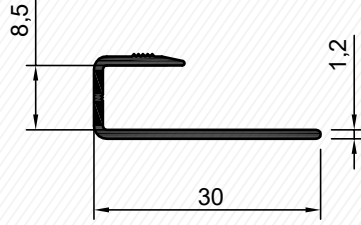

1438
0,158 kg/m

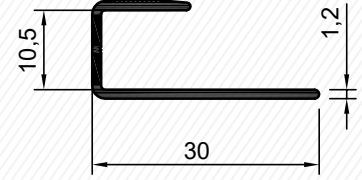

1439
0,171 kg/m

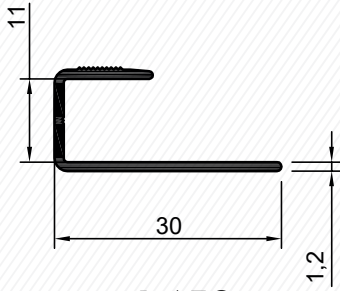

1452
0,172 kg/m

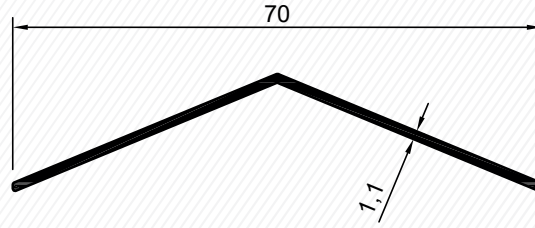

1651
0,225 kg/m

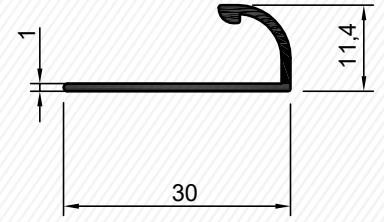

1652
0,139 kg/m

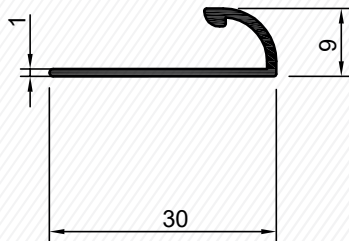

1653
0,131 kg/m

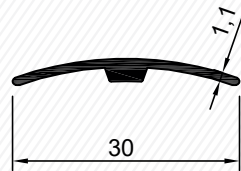

1975
0,116 kg/m

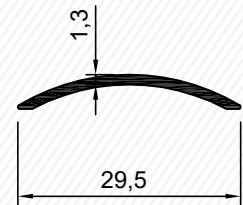

1976
0,104 kg/m

Profiller / Profiles

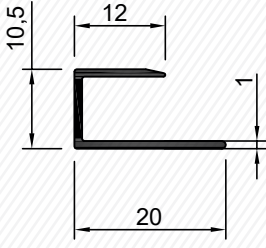
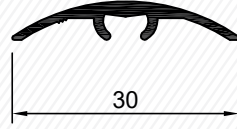
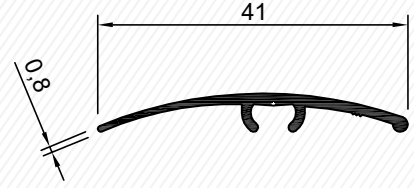
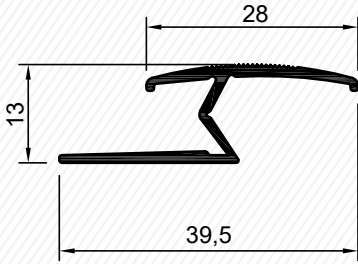
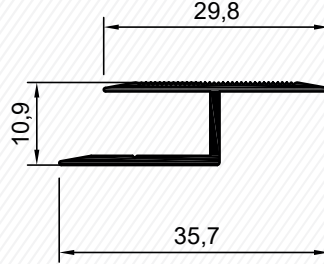
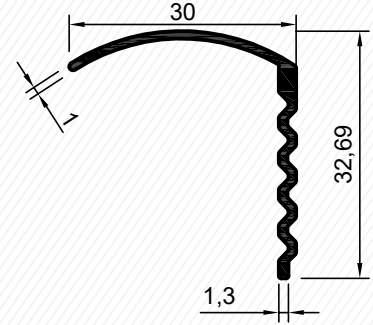
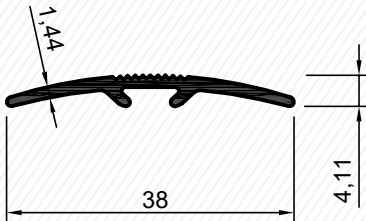
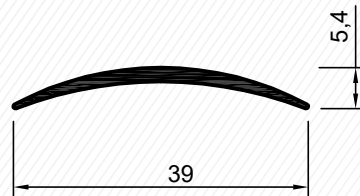
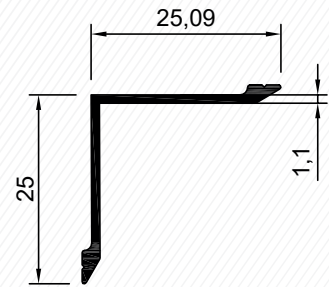
1977
0,107 kg/m1978
0,131 kg/m1979
0,157 kg/m2206
0,208 kg/m2208
0,171 kg/m2724
0,192 kg/m2725
0,170 kg/m2726
0,150 kg/m2727
0,160 kg/m

Profiller / Profiles

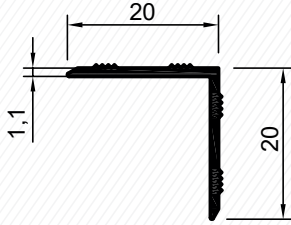

2728
0,119 kg/m

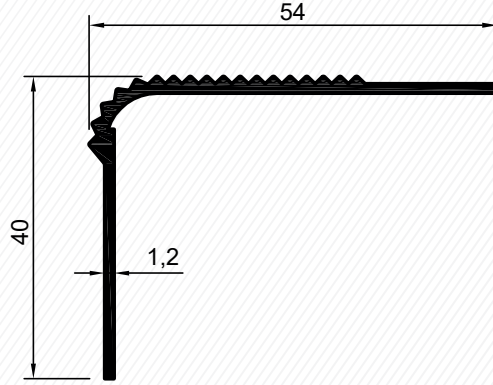

2729
0,355 kg/m

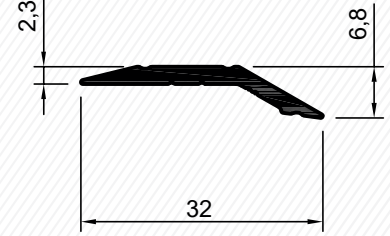

2730
0,167 kg/m

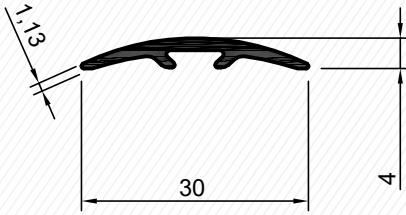

2731
0,141 kg/m

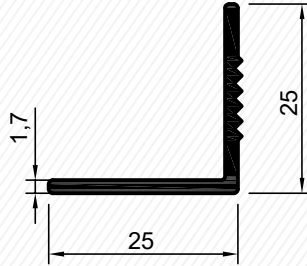

2732
0,222 kg/m

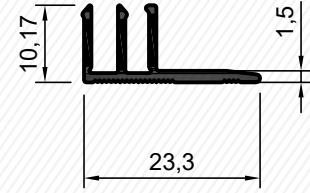

2889
0,151 kg/m

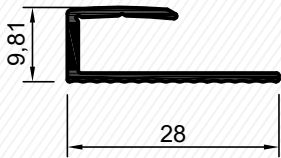

2890
0,150 kg/m

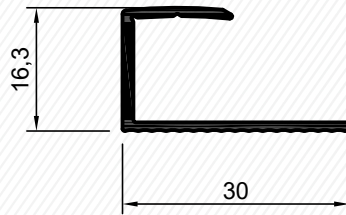

2891
0,181 kg/m

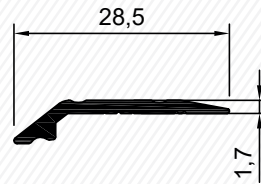

2895
0,129 kg/m

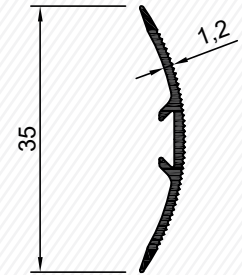

3078
0,121 kg/m

Profiller / Profiles

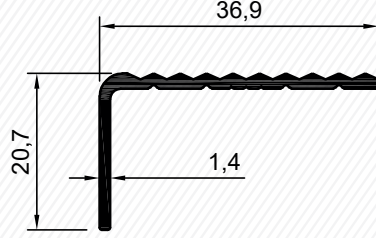
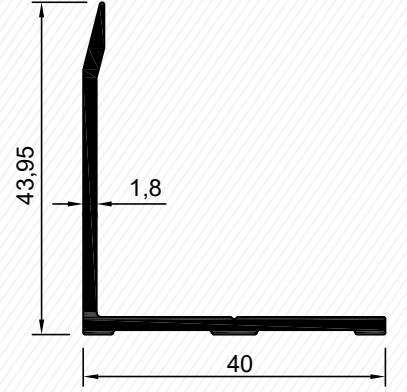
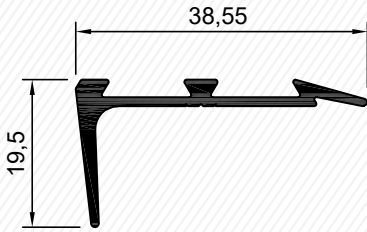
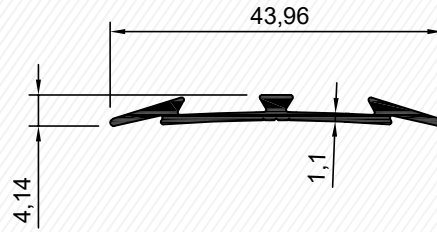
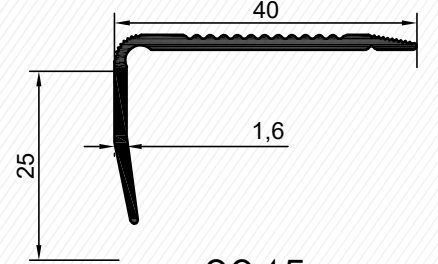
**2896**
0,126 kg/m**2897**
0,226 kg/m**2979**
0,409 kg/m**3043**
0,255 kg/m**3044**
0,185 kg/m**3045**
0,270 kg/m